

Acier Inoxydable | 127.0204.625

FAMILY : Eviers | SERIE : Aton | MODEL : ANX 221 | FINISH : Acier Inoxydable | INSTALLATION TYPE : Flushmount / Slim

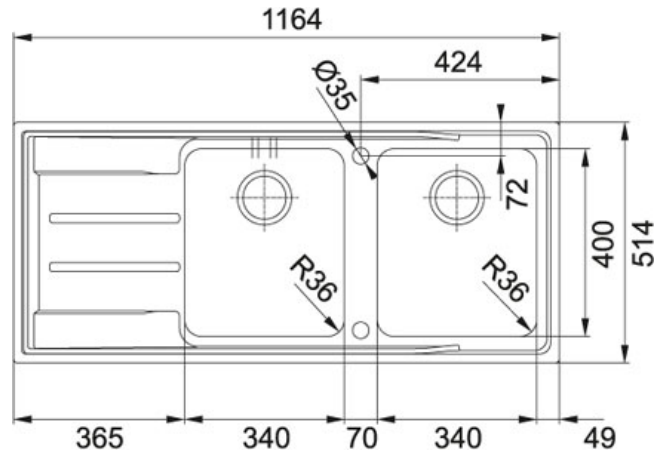

TECHNICAL DATA

Longueur hors tout	1 164,00 mm
Largeur hors tout	514,00 mm
Longueur du grand bac	340,00 mm
Largeur du grand bac	400,00 mm
Profondeur du caisson	180,00 mm
Number of Basins	2
Largeur du caisson	800,00 mm
Evacuation	3 1/2" (Ø 90)
Gabarit	Oui
Cabinet	80 (90 if side end)
Cut-Out	TEMPLATE
Type of Material	STAINLESS-STEEL
Waste Kit Included	YES
Tap Hole	2
Surface Finish	X-BRUSHED/SATIN
Siphon Included	YES
Configuration opposée	127.0204.625

FONCTIONS

NEW	Nouveau		Profil de bord affleurant
AISI 304	AISI 304		Profil de bord mince

